

Ponteiras para aplicações Zeiss

Quando a precisão conta, insista em ponteiras originais da Renishaw. Não fique por menos!

Gama de ponteiras M5

Ponteiras com esfera de rubi (tungsténio)

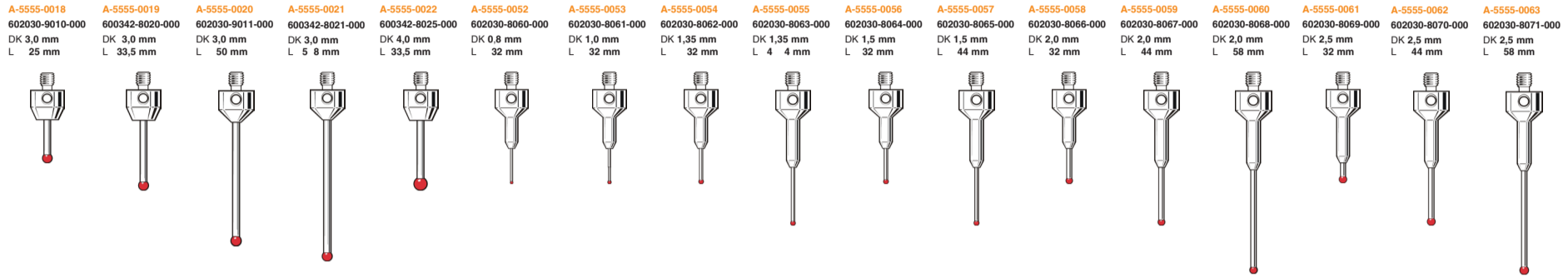

Chave

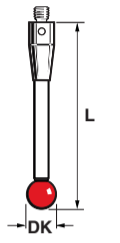

DK DK da esfera
L Ltotal

Ponteiras estrela (tungsténio)

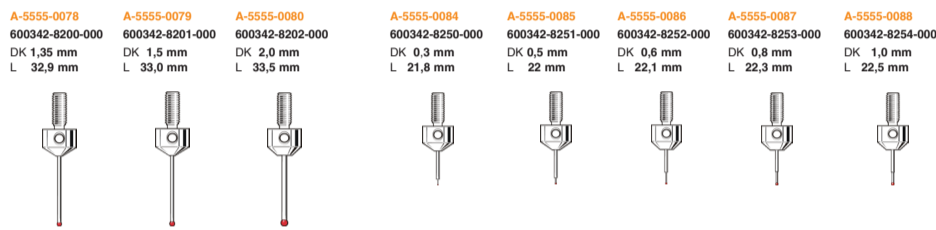

Adaptador de ajuste por rotação (tungsténio)

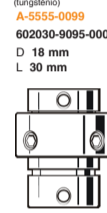

Suporte de ponteiras (1-1,5 mm)

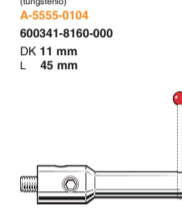

Suporte para até 5 ponteiras (tungsténio)



Sistema de referências

Renishaw:
A-XXXX-XXXX
Zeiss:
6XXXXX-XXXX-XXX

Ponteiras esféricas escalonadas (tungsténio)

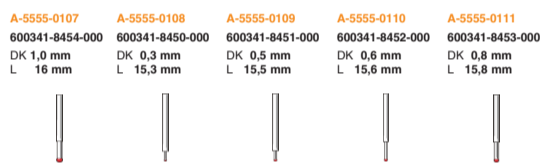

Ponteiras esféricas sem rosca (tungsténio)

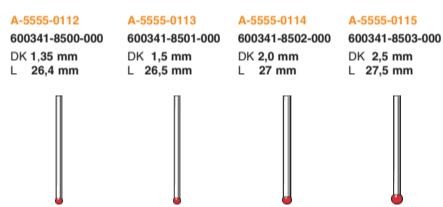

Cubos (titânio)

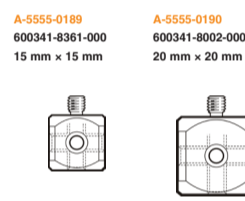

Adaptadores articulados (titânio)

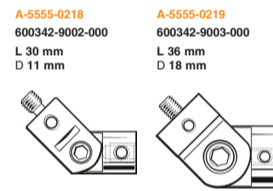

Extensões (tungsténio)

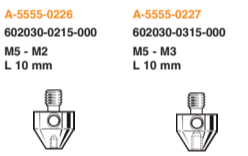

Extensões (alumínio)

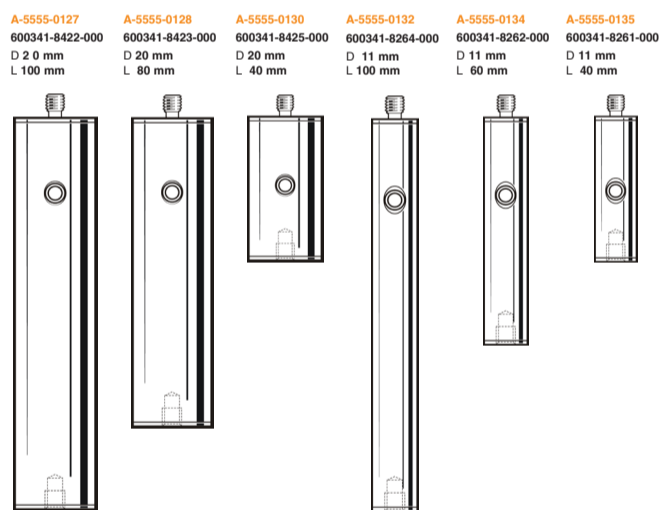

Extensões (aço inox)

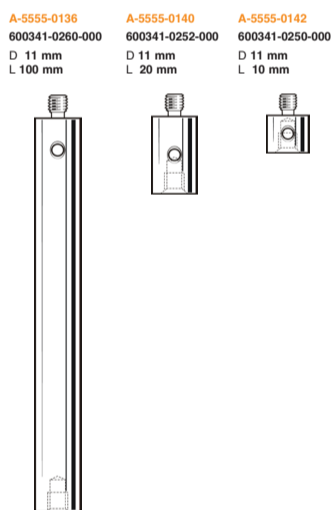

Extensões (titânio)

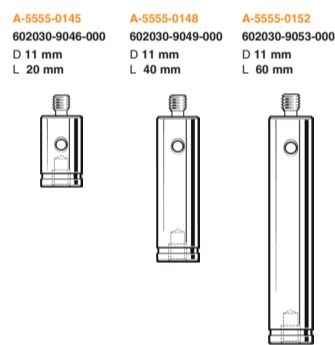

Extensões (fibra de carbono termicamente estável)

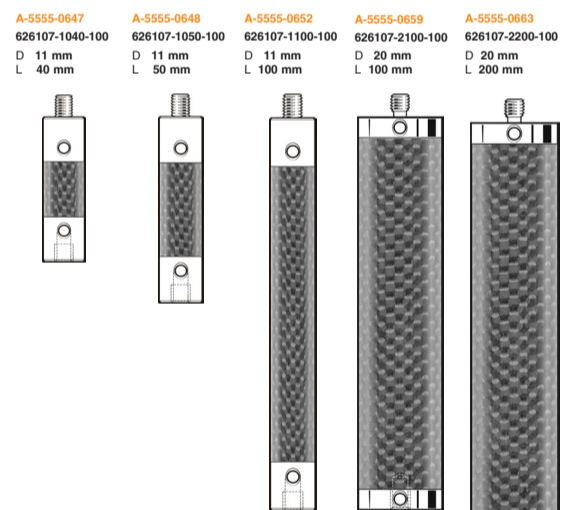

Adaptadores (alumínio)

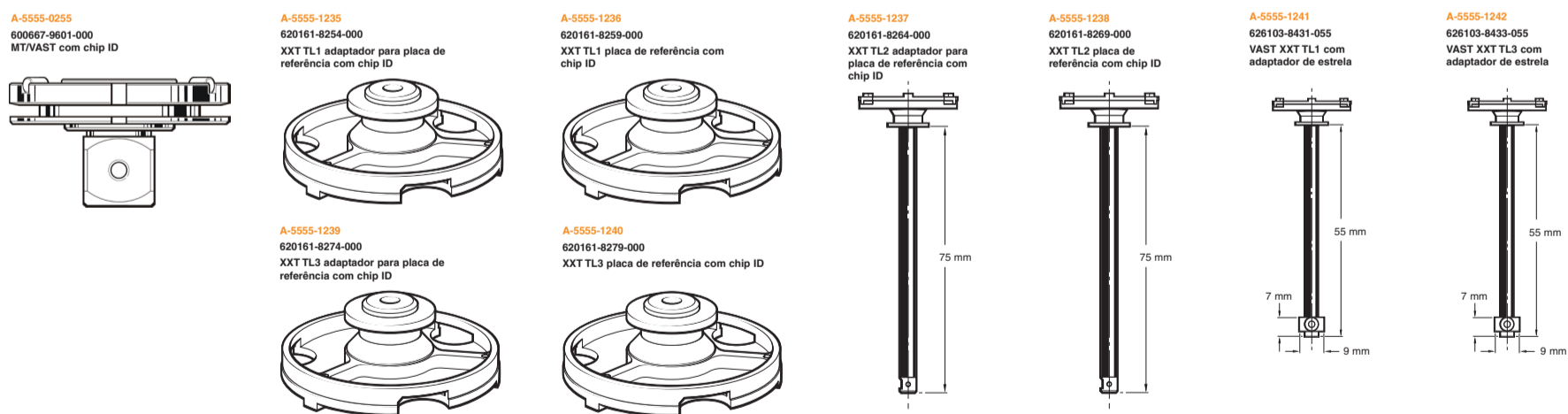

Ponteiras M3 XXT em tungsténio

Ponteiras com esfera em rubi

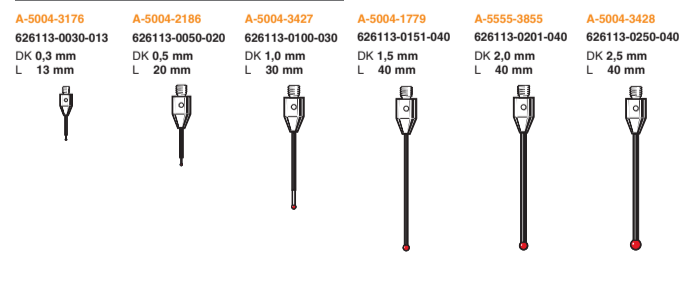

Ponteiras de referência XXT (ponto vermelho)

Ponteiras com esfera em rubi (fibra de carbono)

